

LEGO DIGITAL DESIGNER 4.2

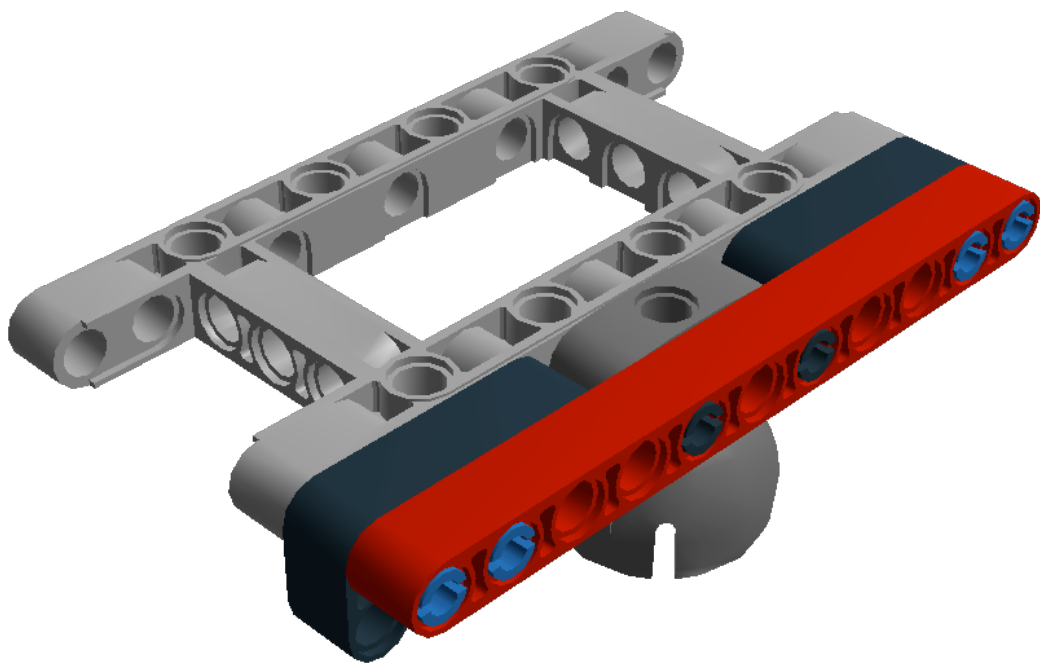

Model Name:
rover-roue-folle
Number of Bricks: 13

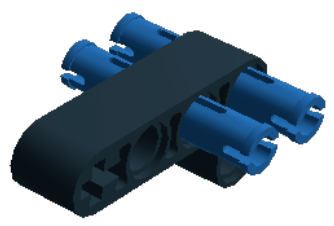
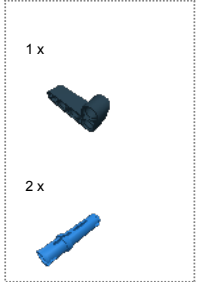

Step 1 of 6



Step 2 of 6

- 2 x 
- 1 x 
- 1 x 

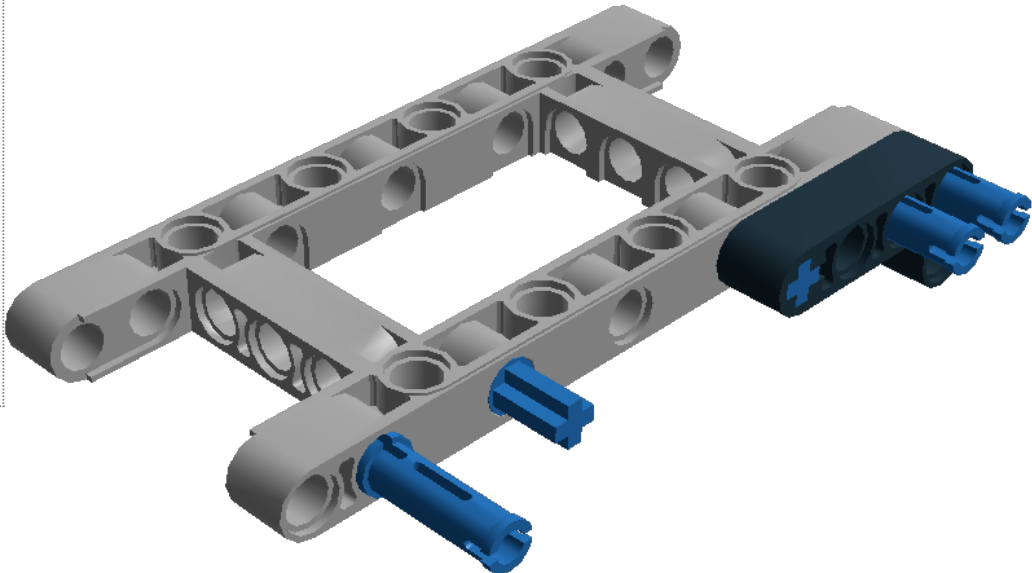

Step 3 of 6

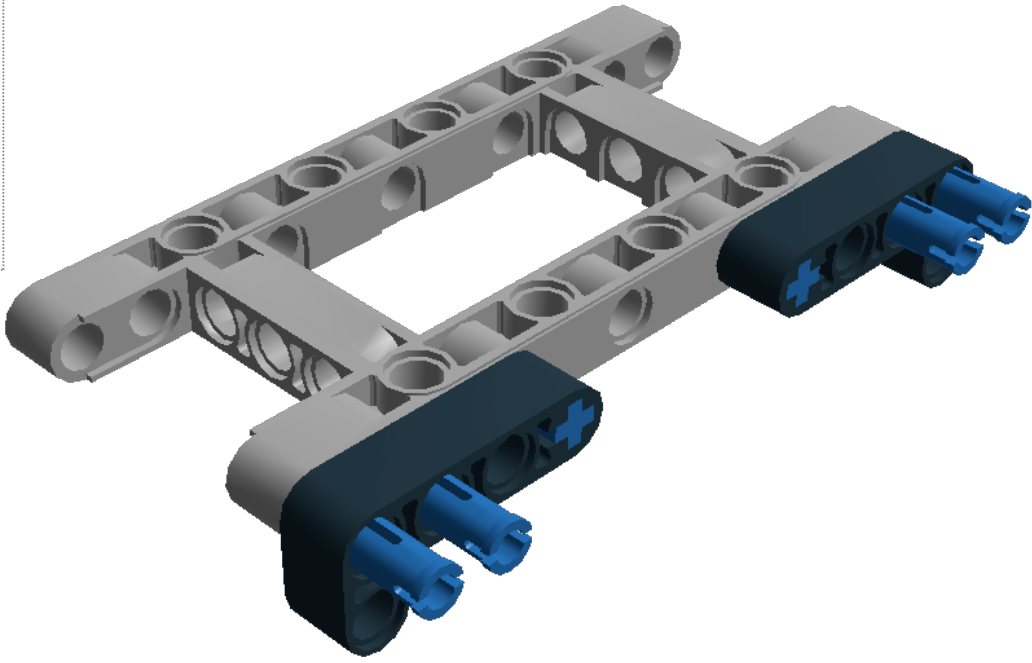
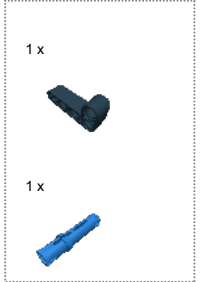

Step 4 of 6

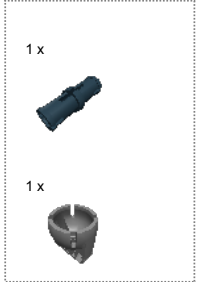

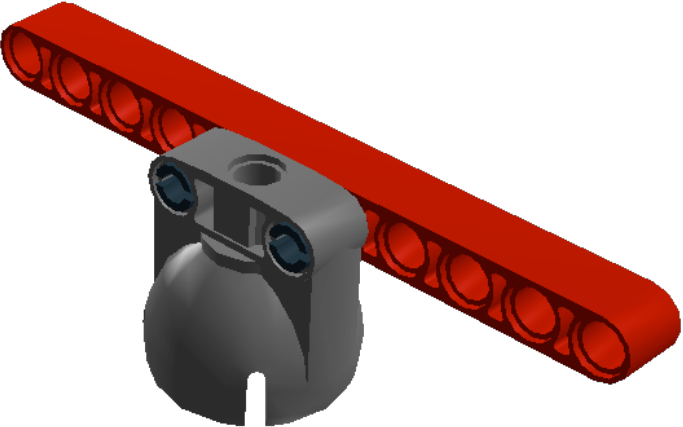
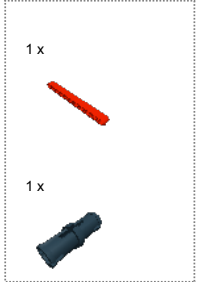

Step 5 of 6



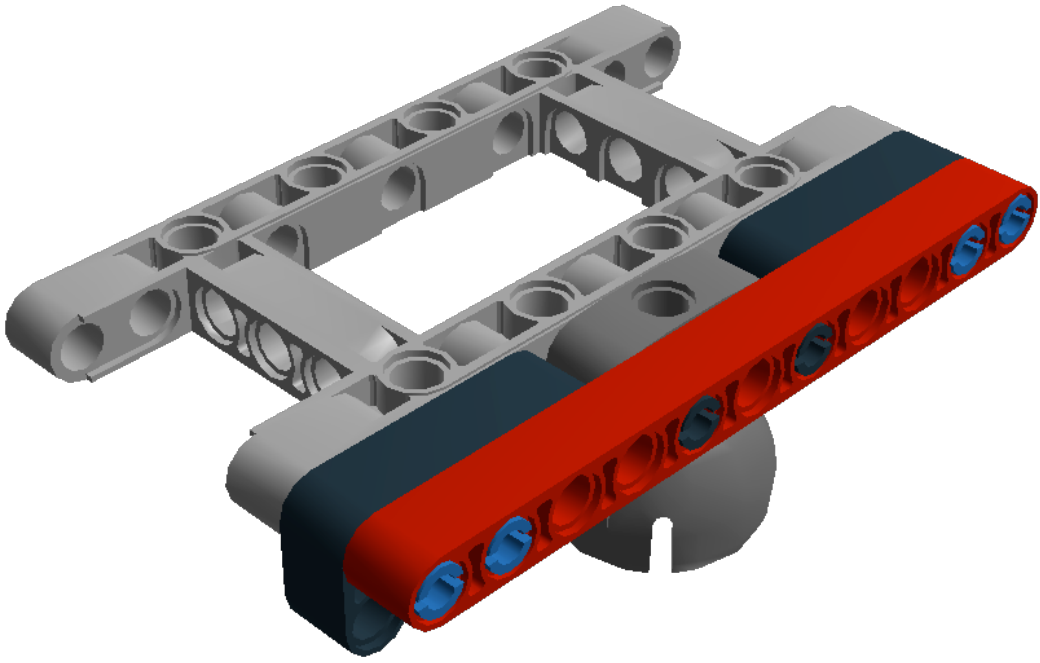

Step 6 of 6



2 x  4120017 TECHNIC ANG. BEAM 4X2
90 DEG - Black

1 x  4562805 TECHNIC 11M BEAM -
Bright Red

2 x  4121715 CONNECTOR PEG W.
FRICTION - Black

2 x  CONN.BUSH
4206482 W.FRIC./CROSSALE -
Bright Blue

4 x  4514553 CONNECTOR PEG W.
FRICTION 3M - Bright Blue

1 x  4610380 POWER JOINT - Dark
Stone Grey

1 x  4540797 BEAM H. FRAME 5X11
Ø4.85 - Medium Stone Grey

© 2012 The LEGO Group. All rights reserved.
Use of the LEGO Digital Designer html print tool, signifies your agreement to the terms of use.